

ROTARY MOTORIZED VALVES  
**MIXING VALVE**  
**SERIES 3F**



Flange

3F, DN 20–150, cast iron, PN 6. Flange.

**OPERATION**

The ESBE series F is a valve made of cast iron for use in heating and cooling installations.

The mixing proportions are adjusted manually with a handle or, in automatically controlled systems, by means of an actuator. Suitable actuators are ESBE series ARC300, ARD100, ARD200 or series 90. The valve can also be equipped with ESBE controllers series 90C and CRA120.

Valve series 3F is available in dimensions DN 20-150 with flanged connections.

The scale is graded on both sides and can be turned, allowing a choice of mounting positions. Operation angle = 90°.

**SERVICE AND MAINTENANCE**

All major parts are replaceable. The shaft seal consist two o-rings, one of which can be replaced without the need for draining down the system or dismantling the valve. However, before doing so, the system must be depressurized.

**INSTALLATION EXAMPLES**

All the examples of installations can be reversed. The valve position plate is graded on both sides and should at the installation be fitted in the correct position as shown in the instruction for installation.

**VALVE 3F DESIGNED FOR**

- Heating
- Comfort cooling

**SUITABLE ACTUATORS AND CONTROLLERS**

- Series 90 ≤DN100
- Series 90C ≤DN100
- Series ARC300
- Series CRA120 ≤DN100
- Series ARD100 ≤DN80
- Series ARD200

**TECHNICAL DATA**

Pressure class: \_\_\_\_\_ PN 6  
 Media temperature: \_\_\_\_\_ max. 110°C  
 \_\_\_\_\_ min. -10°C  
 Differential pressure drop: \_\_\_\_\_ max. 50 kPa  
 Leakrate in % of flow: \_\_\_\_\_ Mixing, max. 1,5% of Kvs  
 \_\_\_\_\_ Diverting, max. 1,0% of Kvs  
 Rangeability Kv/Kv<sup>min</sup>: \_\_\_\_\_ 100  
 Connection: \_\_\_\_\_ Flange according to EN 1092-2

Material \_\_\_\_\_ DN 20–25 \_\_\_\_\_ DN 32–150  
 Valve body: \_\_\_\_\_ Cast iron EN-JL 1030  
 Slide: \_\_\_\_\_ brass CW 614N \_\_\_\_\_ brass CW 614N and  
 \_\_\_\_\_ stainless steel  
 Bushing: \_\_\_\_\_ plastic \_\_\_\_\_ brass CW 602N  
 Cover plate: \_\_\_\_\_ zinc \_\_\_\_\_ cast iron  
 O-rings: \_\_\_\_\_ EPDM

PED 2014/68/EU, article 4.3

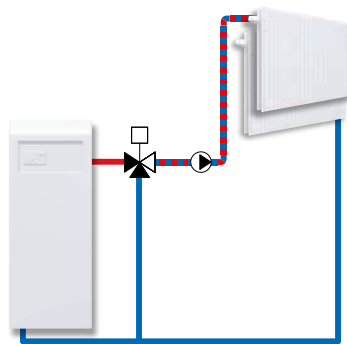

Mixing

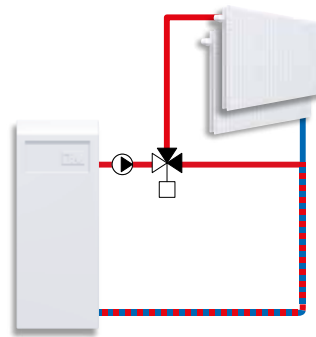

Diverting

# MIXING VALVE SERIES 3F

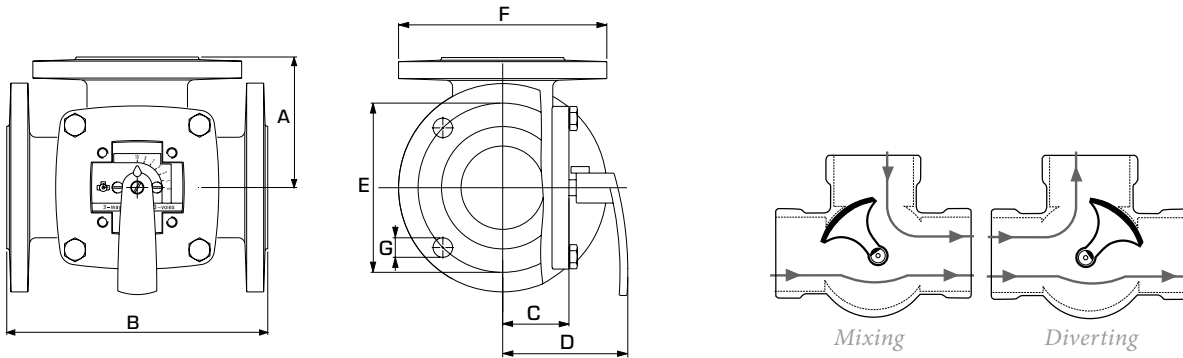

Flanged connection PN6,  
standard EN 1092-2

## SERIES 3F

The flat-sided spindle top  
(as well as the indicator of the knob)  
points towards the sleeve position.

Art. No.	Reference	DN	Kvs *	A	B	C	D	E	F	G	Weight [kg]
11100100	3F 20	20	12	70	140	40	82	65	90	4x11,5	3,5
11100200	3F 25	25	18	75	150	40	82	75	100	4x11,5	4,0
11100300	3F 32	32	28	80	160	40	82	90	120	4x15	5,9
11100400	3F 40	40	44	88	175	40	82	100	130	4x15	6,8
11100600	3F 50	50	60	98	195	50	92	110	140	4x15	9,1
11100800	3F 65	65	90	100	200	52	95	130	160	4x15	10,0
11101000	3F 80	80	150	120	240	63	106	150	190	4x18	16,2
11101200	3F 100	100	225	132	265	73	116	170	210	4x18	21,0
11101400	3F 125	125	280	150	300	80	123	200	240	8x18	27,0
11101600	3F 150	150	400	175	350	88	130	225	265	8x18	37,0

\* Kvs-value in m<sup>3</sup>/h at a pressure drop of 1 bar. Flow chart, see product catalogue.

## SELECTION GUIDE ESBE ACTUATORS

The figures below are intended only as a recommendation for ordinary installations. In some applications the valve may require even more actuator torque.

Actuator	MAXIMUM DIFFERENTIAL PRESSURE					MAXIMUM FLOW				
	ARA600	90	ARC300	ARD100	ARD200	ARA600	90	ARC300	ARD100	ARD200
Torque	6 Nm	15 Nm	30 Nm	10 Nm	20 Nm	6 Nm	15 Nm	30 Nm	10 Nm	20 Nm
DN	max. ΔP [kPa]					max. flow [m <sup>3</sup> /h]				
20	50	50	50	50	50	8,5	8,5	8,5	8,5	8,5
25						13	13	13	13	13
32						20	20	20	20	20
40						31	31	31	31	31
50	—	30	50	30	30	—	42	42	42	42
65	—					64	64	64	64	
80	—					110	110	82	110	
100	—	15	30	30	30	—	120	160	87	160
125	—					—	110	200	—	150
150	—	15	—	—	—	—	160	280	—	220

ROTARY MOTORIZED VALVES  
**MIXING VALVE**  
**SERIES 3F**

**VALVE CHARACTERISTICS**

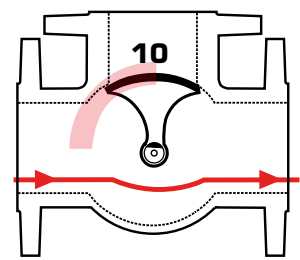
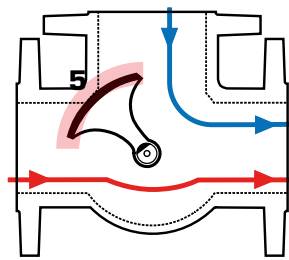
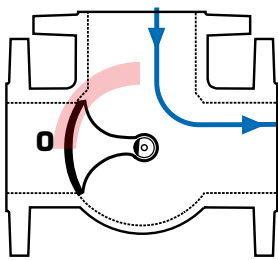
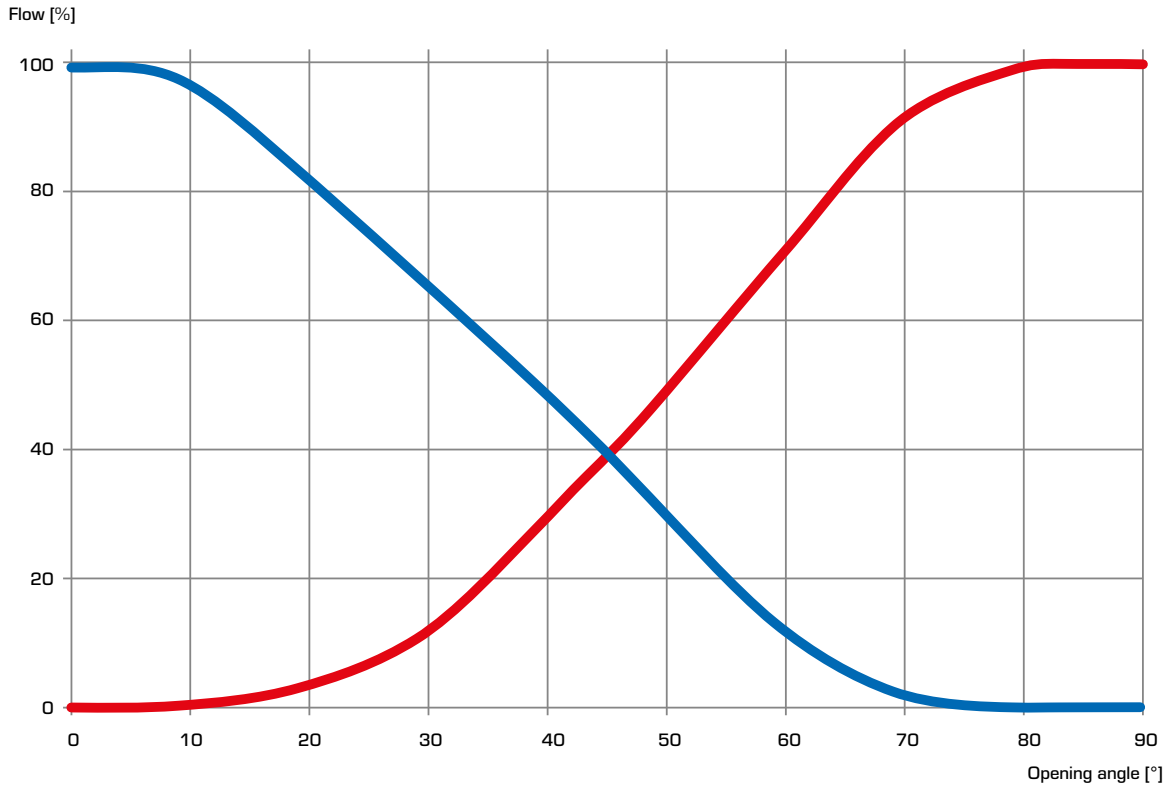

# MIXING VALVE SERIES 3F

## DIMENSIONING

### HEATING SYSTEMS (RADIATOR OR UNDERFLOOR HEATING SYSTEMS)

Start with the heat demand in kW (e.g. 200 kW) and move vertically to the chosen  $\Delta t$  (e.g. 10°C).

Move horizontally to the shaded field (pressure drop of 3-15 kPa) and select the smaller Kvs-value (e.g. 60).  
A mixing valve with suitable Kvs-value will be found in respective product description.

### OTHER APPLICATIONS

Make sure maximum  $\Delta P$  is not exceeded (see line D in the graphs below).

