

H4 Pump Control Set Installation and Commissioning Manual

For underfloor heating with heat pumps and
low temperature systems.

Boxed and pre-assembled ready for installation, including:

- In-built 4-way deflector plate
- Temperature gauge measuring mixed water
- 'A' rated Grundfos UPM3 Auto pump
- 1" Male swivel joints for fast connection to 1" Female manifold tapings
- Nickel plated for improved appearance
- In-built non-return valve in flow elbow to enable simple system filling when commissioning
- 3/4" Female BSP flow and return connections
- Suitable for any manifold with connections on 210mm centres. (Also available in 200 and 225mm)
- Fully reversible offering with side or bottom entry primary connections

1. General

- 1.1** Provides control of flow and return water temperature in an underfloor heating system when using a heat pump or low temperature system. Pre-assembled and tested to ensure that it can be fitted with minimum on-site labour required and commissioned immediately once fitted.
- 1.2** Designed to connect to the right-hand side of a manifold with 200mm as standard (210 / 225mm optional) between the centres of the flow and return arms. The control group can also be altered to fit to the left-hand side of a manifold simply by turning the control group elbows through 180 degrees using the union fittings at the top and bottom of the pump. The pump motor may need to be rotated through 180 degrees to minimise the space occupied by the control group. Primary connections can be applied from the side or bottom of the control pack.

2. Connections & Dimensions

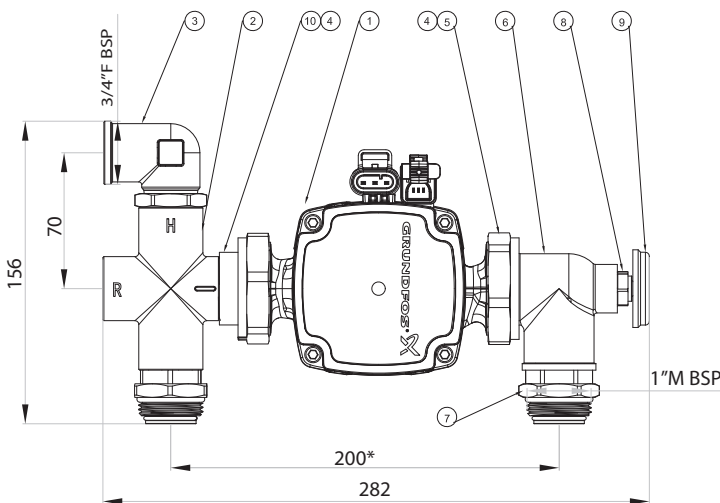

Specification		
1	Grundfos UPM3 Auto Pump	1
2	4-way deflector plate	1
3	Flow / Return Elbow	1
4	2mm Rubber Washer	2
5	1 1/2" Rapid Connection Nut	2
6	Elbow Flanged	1
7	1" Male BSP Flow and Return	2
8	3/8" Pocket	1
9	Temperature Gauge	1
10	Manifold Centre Distance Spacer	1
R	Return from manifold / flow to heat source	N/A
H	Flow from heat source	N/A

*Standard centre distance. 210mm and 225mm also available.

3. Technical Data

Maximum static pressure	10 Bar
Maximum differential pressure	3 Bar
Maximum temperature	95°C
Inlet connections	2 x 3/4" BSPF
Outlet connections	2 x 1" BSPM swivel joint
Overall dimensions (mm)	290 h x 150 w x 140 h (Excluding item.3)
Material	Nickel plated brass
Power	20kW

4. Pre-Installation

Prior to installation, manifold configuration must be determined as left or right handed.

**LB: LEFT HANDED
BOTTOM ENTRY***

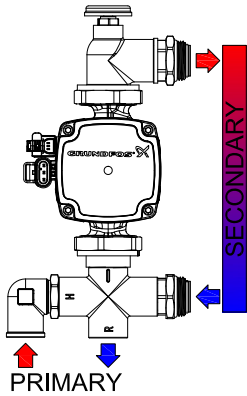

**LS: LEFT HANDED
SIDE ENTRY**

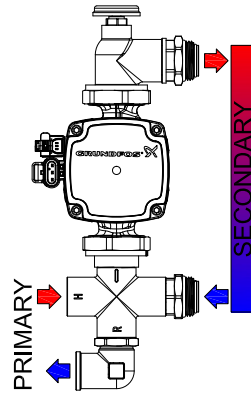

**RB: RIGHT HANDED
BOTTOM ENTRY**

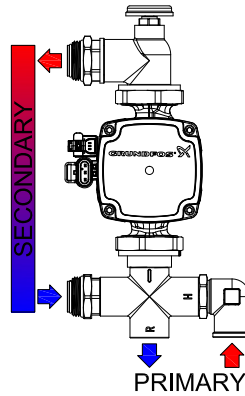

**RS: RIGHT HANDED
SIDE ENTRY**

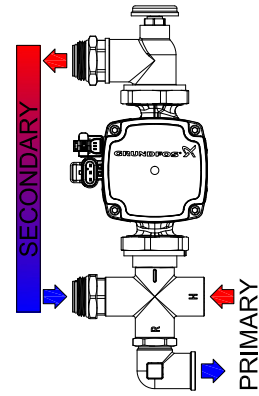

5. Installation

- 5.1** Carefully remove from the packaging and check that all components are in place and that nothing has been damaged during delivery.
- 5.2** The pump pack is supplied for connection to the right-hand side of the manifold but can be altered very simply for connection to the left-hand side. (See above)
- 5.3** To change orientation:
Loosen the pump rotating nuts (5) on the 4-way deflector plate (6) and rotate through 180 degrees. Re-tighten nut (5) after rotation.
- 5.4** Pipe connection orientation can be altered to suit using flow / return elbow (3) (supplied loose) fitted in either flow or return.
- 5.5** A swivel joint is fitted to each side of the control group for connecting to the 1" F manifold tappings. Carefully offer up and screw the swivel joint threads evenly into the manifold using a 37mm A/F spanner: the use of a 31mm A/F spanner will also ensure that the connection to the pump mixer is kept tight. The joints use o-ring seals and care should be taken not to over-tighten them.
- 5.6** Once connected, finish securing the manifold and pump pack to the wall if not already completed.
- 5.7** The primary flow and return pipework can now be connected to the 2 x 3/4" F connections on the 4-way deflector plate. The flow connection is at the H and the return connection is at the R. It is recommended that ball valves are used to isolate this pipework where it is connected to the pump mixer.

6. Commissioning

6.1 Filling the UFH system - The in-built non-return valve in the flow elbow allows you to fill the circuits from the upper flow rail drain and fill valve only.

Be aware that you cannot get the benefit of this feature when filling via the primary flow and return connections or the lower manifold rail drain and fill valve.

6.2 The pump pack, manifold and underfloor circuits can now be filled and commissioned in accordance with the manifold instructions. Prior to filling, a final check of all joints should be made to ensure no connections have loosened during transit.

6.3 The pump is supplied with a pre-connected 1m long 3-core lead assembly ready for connection to the electrical control system. Ensure that the pump is filled and vented, operate the control system to call for heat then select the desired pump setting.

The H4 control pack comes pre-assembled ready for installation. Please ensure the pump connections are tightened before commissioning. These connections are equipped with EPDM seals.

7. Pump control modes and functions

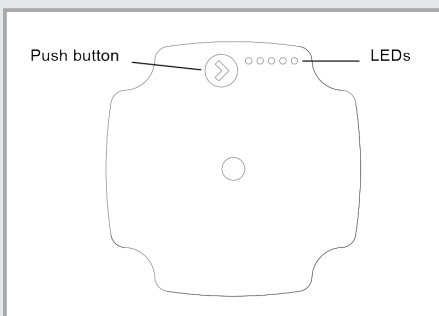

The user interface is designed with a single push button, one red/green LED and four yellow LEDs.

The User Interface shows:

- Performance view (during operation)
 - Operation status
 - Alarm status
- Settings view (after pressing the button)

During operation, the display shows the performance view. If you press the button, the user interface switches the view or runs in the setting selection mode.

Alarm status

If the circulator has detected one or more alarms, the bi-colored LED 1 switches from green to red. When an alarm is active, the LEDs indicate the alarm type as defined in the table below. If multiple alarms are active at the same time, the LEDs only show the error with the highest priority. The priority is defined by the sequence of the table. When there is no active alarm anymore, the user interface switches back to operation mode.

Display	Indication	Pump operation	Counter action
One red LED + one yellow LED (LED 5)	Rotor is blocked	Trying to start again every 1.33 seconds.	Wait or unblock the shaft.
One red LED + one yellow LED (LED 4)	Supply voltage too low	Only warning, pump runs.	Control the supply voltage.
One red LED + one yellow LED (LED 3)	Electrical error	Pump is stopped because of low supply voltage or serious failure.	Control the supply voltage / Exchange the pump.

7. Pump control modes and functions - continued

Performance view

The performance view shows either the operation status or the alarm status.

Operation status

When the circulator is running, LED 1 is green. The four yellow LEDs indicate the current power consumption (P1) as shown in the table below. When the operation mode is active, all active LEDs are constantly on in order to differentiate this mode from the select setting mode. If the circulator is stopped by an external signal, LED 1 flashes green.

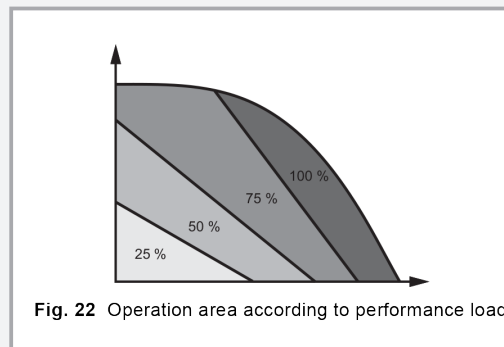
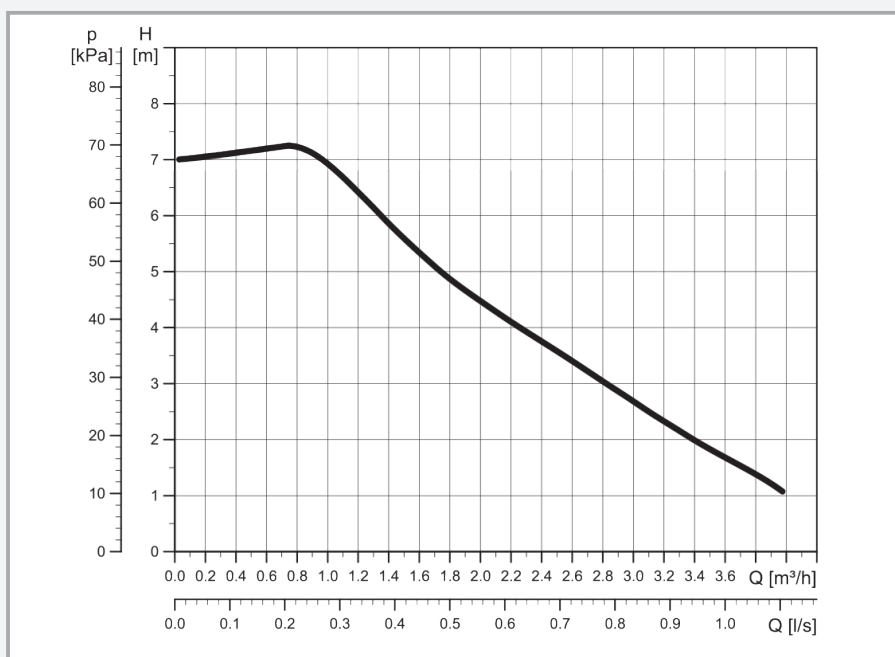
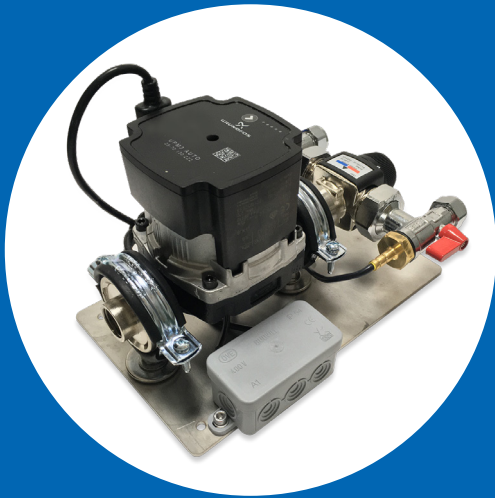

Fig. 22 Operation area according to performance load

Display	Indication	Performance in % of P1 MAX
One green LED (flashing)	Standby (only externally controlled)	0
One green LED + one yellow LED	Low performance	0-25
One green LED + two yellow LED	Medium low performance	25-50
One green LED + three yellow LED	Medium high performance	50-75
One green LED + four yellow LED	High performance	75-100



Our other UFH products:



Single-loop Pump Pack

The single-loop assembly is designed to connect to new and existing heating systems with 15mm compression connections for the flow and return.

The temperature switch supplies power to the pump and will remain open until the existing heating system water is above 40°C. Following this, the switch will close activating the 'A' rated pump, which will allow the TMV to mix flow and return to the required UFH temperature. Unit is suitable for use with floor areas of 60–90sqm or max output of 5kW.



Thermostatic Pump Pack

The ESBE T4 pump pack is designed to control the UFH flow temperature between 20°C–55°C (BS1264 forced screed drying). Complete with ESBE 3.4kv 4-port thermostatic mixing valve, 'A' rated pump, built-in check valve and temperature gauge. Offering pipe centres of 210mm, 200mm and 225mm, fully reversible with side or bottom entry primary connections. This unit is suitable for use with floor areas up to 220sqm or a max output of 18kW.

