



ESBE T4 Pump Control Set Installation and Commissioning Manual

For underfloor heating with thermostatic mixing valve.

Boxed and pre-assembled ready for installation, including:

- ESBE Thermostatic mixing valve, adjustable from 20°C to 55°C (BS2164)
- Temperature gauge measuring mixed water
- 'A' rated Wilo Para 25/6 SCU Pump
- 1" Male swivel joints for fast connection to 1" Female manifold tapings
- Nickel plated for improved appearance
- In-built non-return valve in flow elbow to enable simple system filling when commissioning
- 3/4" Female BSP flow and return connections
- Suitable for any manifold with connections on 210mm centres (Also available in 200 and 225mm)
- Fully reversible offering with side or bottom entry primary connections

1. General

- 1.1** Provides control of flow and return water temperature in an underfloor heating system. Pre-assembled and tested to ensure that it can be fitted with minimum on-site labour required and commissioned immediately once fitted.
- 1.2** Designed to connect to the right-hand side of a manifold with 200mm as standard (210 / 225mm optional) between the centres of the flow and return arms. The control group can also be altered to fit to the left-hand side of a manifold simply by turning the control group elbows through 180 degrees, using the union fittings at the top and bottom of the pump. The pump motor may need to be rotated through 180 degrees to minimise the space occupied by the control group. Primary connections can be applied from the side or bottom of the control pack.

2. Connections & Dimensions

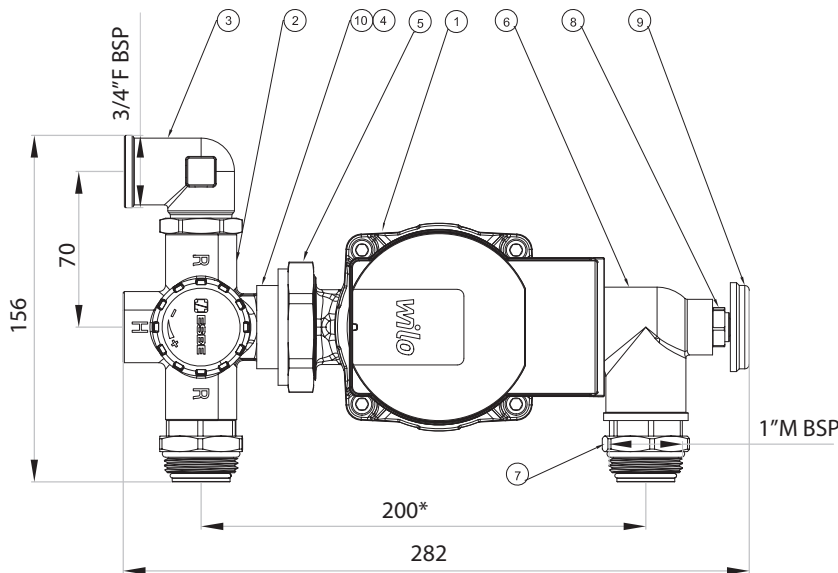

Item	Description	Qty
1	WILO 25/6-SCU Pump	1
2	ESBE Thermostatic Mixing Valve	1
3	Flow / Return Elbow	1
4	2mm Rubber Washer	2
5	1 1/2" Rapid Connection Nut	2
6	Elbow Flanged	1
7	1" Male BSP Flow and Return	2
8	3/8" Pocket	1
9	Temperature Gauge	1
10	Manifold Centre Distance Spacer	1
R	Return from Manifold / Flow to Heat Source	NA
H	Flow from Heat Source	NA

*STANDARD CENTRE DISTANCE. 210MM & 225MM ALSO AVAILABLE

3. Technical Data

Maximum static pressure	10 Bar
Maximum differential pressure	3 Bar
Maximum temperature	95°C
Operating temperature range	Adjustable between 20°C to 55°C (BS2164)
Inlet connections	2 x 3/4" BSPF
Outlet connections	2 x 1" BSPM swivel joint
Overall dimensions (mm)	290 h x 150 w x 140 h (Excluding item.3)
Kvs	3.4
Material	Nickel plated brass
Power	18kW

4. Pre-Installation

Prior to installation, manifold configuration must be determined as left or right handed.

LB: LEFT HANDED
BOTTOM ENTRY*

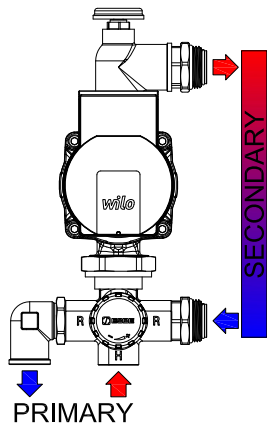

LS: LEFT HANDED
SIDE ENTRY

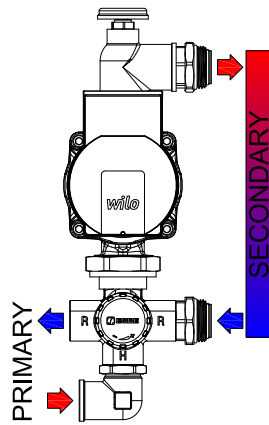

RB: RIGHT HANDED
BOTTOM ENTRY

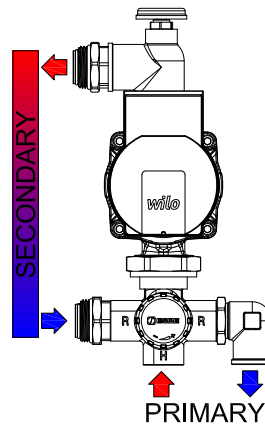

RS: RIGHT HANDED
SIDE ENTRY

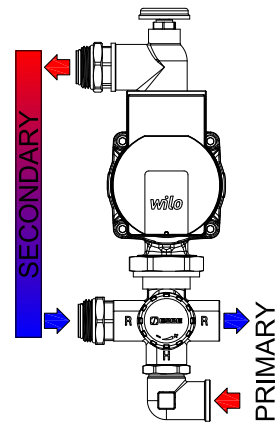

5. Installation

- 5.1** Carefully remove from the packaging and check that all components are in place and that nothing has been damaged during delivery.
- 5.2** The pump mixer is supplied for connection to the right-hand side of the manifold but can be altered very simply for connection to the left-hand side. (See above)
- 5.3** To change orientation:
 - a) Remove swivel nut (7) from the TMV and move to opposite connection. (These joints use o-ring seals and should not be overtightened)
 - b) Loosen the pump rotating nuts (5) on the elbow (6) and rotate through 180 degrees. Re-tighten nut (5) after rotation.
- 5.4** Pipe connection orientation can be altered to suit using flow / return elbow (3) (supplied loose) fitted in either flow or return.
- 5.5** A swivel joint is fitted to each side of the control group for connecting to the 1" F manifold tapplings. Carefully offer up and screw the swivel joint threads evenly into the manifold using a 37mm A/F spanner: the use of a 31mm A/F spanner will also ensure that the connection to the pump mixer is kept tight. The joints use o-ring seals and care should be taken not to over-tighten them.
- 5.6** Once connected, finish securing the manifold and large area mixer to the wall if not already completed.
- 5.7** The primary flow and return pipework can now be connected to the 2 x 3/4" F connections. The flow connection is at the H and the return connection is at the R. It is recommended that ball valves are used to isolate this pipework where it is connected to the pump mixer.

6. Commissioning

6.1 Filling the UFH system - the inbuilt non-return valve in the flow elbow allows you to fill the circuits from the upper flow rail drain and fill valve only.

Be aware that you cannot get the benefit of this feature when filling via the primary flow and return connections or the lower manifold rail drain and fill valve.

6.2 The mixer, manifold and underfloor circuits can now be filled and commissioned in accordance with the manifold instructions. Prior to filling, a final check of all joints should be made to ensure no connections have loosened during transit.

6.3 The pump is supplied with a pre-connected 1m long 3-core lead assembly ready for connection to the electrical control system. Ensure that the pump is filled and vented, operate the control system to call for heat then select the desired pump setting.

The ESBE T4 control pack comes pre-assembled ready for installation, please ensure the pump connections are tightened before commissioning. These connections are equipped with EPDM seals.

7. Pump control modes and functions

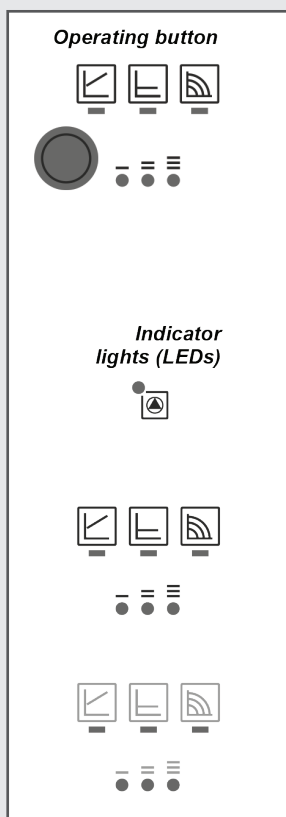

- Signal display
- LED is lit up green in normal operation
- LED lights up/flashes in case of a fault
- Display of selected pump mode
- Display of selected pump curve (I, II,III) within the control mode.
- LED indicator combinations during the pump venting function, manual restart and key lock.

Temperature Setpoints in °C	20	25	30	35	40	45	50	55

7. Pump control modes and functions - Continued

Variable differential pressure

Recommended for two-pipe heating systems with radiators to reduce the flow noise at thermostatic valves. The pump reduces the delivery head to half in the case of decreasing volume flow in the pipe network. Electrical energy saving is achieved by adjusting the delivery head to the volume flow requirement and lower flow rates. There are three pre-defined pump curves (I, II, III) to choose from.

Recommended for underfloor heating for large-sized pipes or all applications without a variable pipe network curve (e.g. storage charge pumps), as well as single-pipe heating systems with radiators. The control keeps the set delivery head constant irrespective of the pumped volume flow. There are three pre-defined pump curves (I, II, III) to choose from.

Variable differential pressure $\Delta p-v$ (I, II, III)

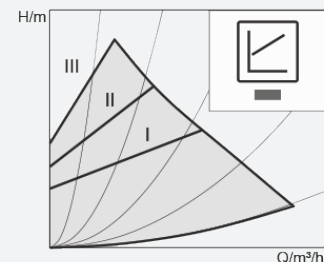

Constant differential pressure

Recommended for underfloor heating for large-sized pipes or all applications without a variable pipe network curve (e.g. storage charge pumps), as well as single-pipe heating systems with radiators. The control keeps the set delivery head constant irrespective of the pumped volume flow.

Constant differential pressure $\Delta p-c$ (I, II, III)

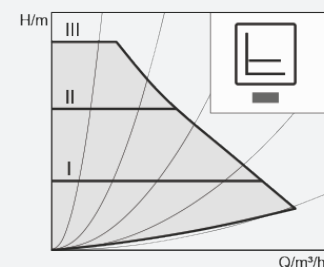

Constant speed

There are three pre-defined pump curves (I, II, III) to choose from. Recommended for systems with fixed system resistance requiring a constant volume flow. The pump runs in three prescribed fixed speed stages (I, II, III).

Note: Factory setting: Constant speed, pump curve III

Constant speed (I, II, III)

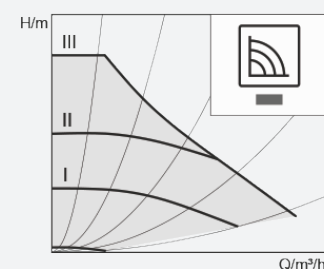

Our other UFH products:

Single-loop Pump Pack

The single-loop assembly is designed to connect to new and existing heating systems with 15mm compression connections for the flow and return.

The temperature switch supplies power to the pump and will remain open until the existing heating system water is above 40°C. Following this, the switch will close activating the 'A' rated pump, which will allow the TMV to mix flow and return to the required UFH temperature. Unit is suitable for use with floor areas of 60–90sqm or max output of 5kW.



Heat Pump Pack

The heat pump model is a pre-assembled unit that is designed to be connected (via ball valves) to the manifold. The unit is for use in applications where water temperature controls are not required. This is typically seen where heat pumps or low temperature systems are utilised.

The unit includes an 'A' rated energy efficient pump and is suitable for use with floor areas up to 250sqm or a maximum output of 20kW. Primary flow and return connections can be made from the side or the bottom of the unit. This can also be mounted on either the left- or right-hand side of the manifold.



