

# MIXING VALVE SERIES VRB140

The compact rotary mixing valve series VRB140 for bivalent heating systems is available in DN 15–50, and is made of brass. Three types of connections are available; internal thread, external thread and compression fittings. PN 10. Patented + Registered design.

## OPERATION

ESBE series VRB140 is a range of compact rotary mixing valve developed for bivalent systems, i.e. where two heat sources are connected in series or parallel. With an actuator and a control device, the ESBE VRB140 can be used to prioritize between heat sources.

For easy manual operation the valves are equipped with non-slip knobs and end stops for an operation angle of 90°. The valve position scale can be turned over and rotated, allowing a wide choice of mounting positions. Together with actuator series ESBE ARA600, the VRB140 valves are also easily automated and have extraordinary regulating accuracy thanks to the unique valve-to-actuator interface. For more advanced control functions, the ESBE controllers allows even more applications.

ESBE VRB140 valves are available in dimensions DN 15–50 with internal thread, in DN 15–50 with external thread and with compression fittings for pipe O.D. 22 and 28 mm.

## FUNCTION

The BIV valve has two inlets to which the heat sources can be connected either in parallel or in series. The primary, i.e. the low grade heat source should be connected to port 1 and the secondary to port 2. When no heat is needed, both ports 1 and 2 are closed. When heat is needed, the supply from port 1 is used as long as the required temperature can be maintained. When this is no longer the case the valve provides initially a mixed flow from ports 1 and 2. Finally port 2 is fully open and port 1 closed. (The function is like a 3-way valve but with two inlets instead of one.)

The BIV valve may also be used on water storage tanks where two outlets from the tank are required. One outlet at the top of the tank and one half way down the tank serve the valve and the return line from the heating system is connected to the bottom of the tank. With this arrangement the hot water from the top of the tank will be used in conjunction with the cooler water drawn from the mid position.

## SERVICE AND MAINTENANCE

The slender and compact design of the valve allows for easy tool access when assembling and disassembling the valve.

Repair kits are available for key components.



Internal thread



External thread



Compression fitting

## VALVE VRB140 DESIGNED FOR

- Heating
- Floor heating
- Comfort cooling
- Solar heating

## SUITABLE ACTUATORS AND CONTROLLERS

- Series ARA600
- Series 90C
- Series 90\*
- Series CRD100
- Series CRC110, CRC120\*, CRC140
- Series CRB100
- Series CRA110, CRA120\*, CRA140, CRA150

\*Adaptor kit necessary

## TECHNICAL DATA

Pressure class: \_\_\_\_\_ PN 10  
 Media temperature: \_\_\_\_\_ max. (continuously) +110°C  
 \_\_\_\_\_ max. (temporarily) +130°C  
 \_\_\_\_\_ min. -10°C  
 Torque (at nominal pressure) DN15-32: \_\_\_\_\_ < 3 Nm  
 DN40-50: \_\_\_\_\_ < 5 Nm  
 Leakrate in % of flow\*: \_\_\_\_\_ < 0,5%  
 Working pressure: \_\_\_\_\_ 1 MPa (10 bar)  
 Max. differential pressure drop: \_\_\_\_\_ Mixing, 100 kPa (1 bar)  
 \_\_\_\_\_ Diverting, 200 kPa (2 bar)  
 Close off pressure: \_\_\_\_\_ 200 kPa  
 Rangeability Kv/Kv<sup>min</sup>, A-AB: \_\_\_\_\_ 100  
 Connections: \_\_\_\_\_ Internal thread, EN 10226-1  
 \_\_\_\_\_ External thread, ISO 228/1  
 \_\_\_\_\_ Compression fitting, EN 1254-2

\* Differential pressure 100kPa (1 bar)

### Material

Valve body: \_\_\_\_\_ Dezincification resistant brass, DZR  
 Slide: \_\_\_\_\_ Abrasion resistant brass  
 Shaft and bushing: \_\_\_\_\_ PPS composite  
 O-rings: \_\_\_\_\_ EPDM

PED 2014/68/EU, article 4.3

## VALVE CHARACTERISTICS

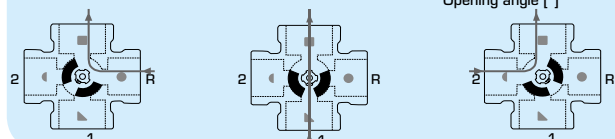
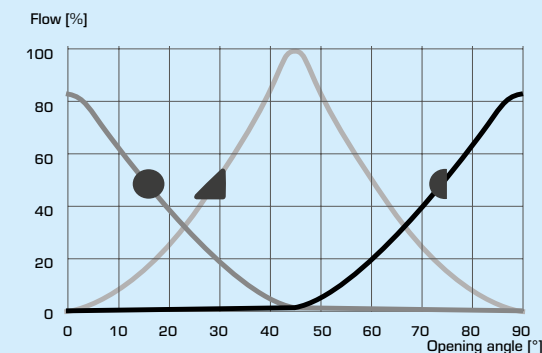

# MIXING VALVE SERIES VRB140

## INSTALLATION EXAMPLES

All the examples of installation can be mirrored. The valve position scale can be turned over and rotated to fit a number of installation layouts and shall at the installation be fitted in the correct position as shown in the instruction for installation. The symbol markings of the valve ports (■●▲) minimize the risk of incorrect installation.

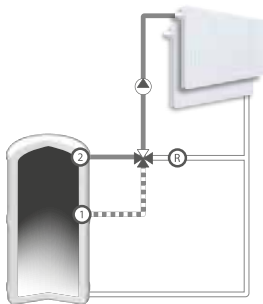

*Storage tank mixing*

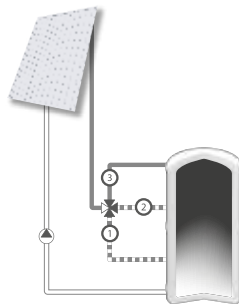

*Storage tank loading*

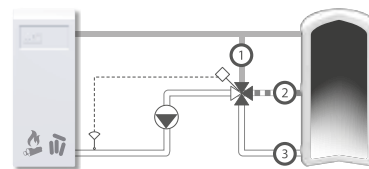

*Storage tank loading*

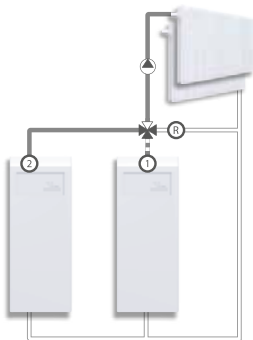

*Parallel heat sources*

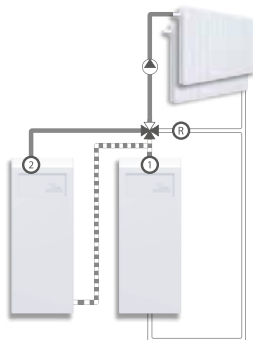

*Serial heat sources*

# MIXING VALVE SERIES VRB140

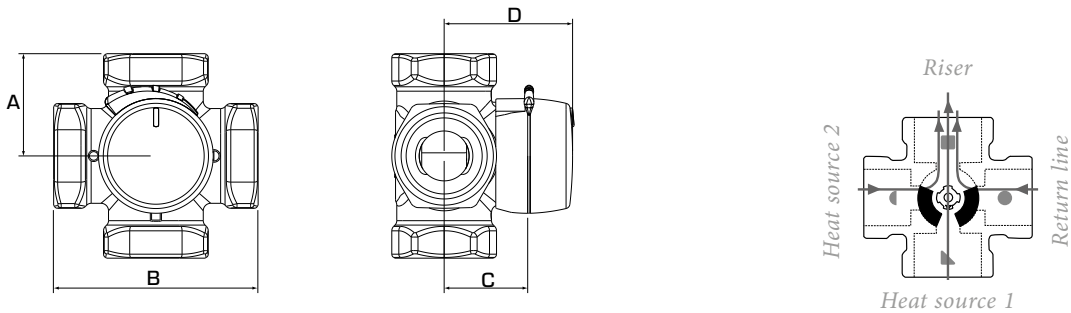

The flat-sided spindle top points towards the sleeve input.

## SERIES VRB141, INTERNAL THREAD

Art. No.	Reference	DN	Kvs*	Connection	A	B	C	D	Weight [kg]	Note
11660100	VRB141	15	2,5	Rp 1/2"	36	72	32	50	0,40	
11660200	VRB141	20	4	Rp 3/4"	36	72	32	50	0,52	
11660300			6,3							
11660400	VRB141	25	10	Rp 1"	41	82	34	52	0,80	
11660500	VRB141	32	16	Rp 1 1/4"	47	94	37	55	1,08	
11662000	VRB141	40	25	Rp 1 1/2"	53	106	44	62	1,98	
11662200	VRB141	50	35	Rp 2"	60	120	46	64	2,65	

## SERIES VRB142, EXTERNAL THREAD

Art. No.	Reference	DN	Kvs*	Connection	A	B	C	D	Weight [kg]	Note
11660800	VRB142	15	2,5	G 3/4"	36	72	32	50	0,40	
11662400			4							
11660900	VRB142	20	4	G 1"	36	72	32	50	0,52	
11661000			6,3							
11661100	VRB142	25	10	G 1 1/4"	41	82	34	52	0,80	
11661200	VRB142	32	16	G 1 1/2"	47	94	37	55	1,08	
11662100	VRB142	40	25	G 2"	53	106	44	62	1,99	
11662300	VRB142	50	35	G 2 1/4"	60	120	46	64	2,65	

## SERIES VRB143, COMPRESSION FITTING

Art. No.	Reference	DN	Kvs*	Connection	A	B	C	D	Weight [kg]	Note
11661500	VRB143	20	4	CPF 22 mm	36	72	32	50	0,40	
11661600			6,3							
11661700	VRB143	25	6,3	CPF 28 mm	36	72	32	52	0,45	

\* Kvs-value in m<sup>3</sup>/h at a pressure drop of 1 bar; Flow chart, see product catalogue. CPF = compression fitting.

# MIXING VALVE SERIES VRB140

## DIMENSIONING

### RADIATOR OR UNDERFLOOR HEATING SYSTEMS

Start with the heat demand in kW (e.g. 25 kW) and move vertically to the chosen  $\Delta t$  (e.g. 15°C).

Move horizontally to the shaded field (pressure drop of 3-15 kPa) and select the smaller Kvs-value (e.g. 4.0). A mixing valve with suitable Kvs-value will be found in respective product description.

### OTHER APPLICATIONS

Make sure maximum  $\Delta P$  is not exceeded (see lines A and B in the graph below).

