

MIXING VALVE SERIES VRG130

The compact rotary 3-way mixing valve series VRG130 is available in DN 15–50, and is made of brass, PN10. Five types of connections are available; internal thread, external thread, compression fitting, rotating nut and pump flange. Patented + Registered design.

OPERATION

The ESBE series VRG130 is a range of compact low leakage mixing valves made of special brass alloys allowing use in heating and cooling installations.

For easy manual operation the valves are equipped with non-slip knobs and end stops for an operation angle of 90°. The valve position scale can be turned over and rotated, allowing a wide choice of mounting positions. Together with actuator series ESBE ARA600 the VRG130 valves are also easily automated and have extraordinary regulating accuracy thanks to the unique valve-to-actuator interface. For more advanced control functions, the ESBE controllers allows even more applications.

ESBE VRG130 valves are available in dimensions DN 15–50 with internal or external thread, with rotating nut and pump flange in DN20, or with compression fittings for pipe O.D. 22 and 28 mm.

SERVICE AND MAINTENANCE

The slender and compact design of the valve allows for easy tool access when assembling and disassembling the valve.

Repair kits are available for key components.

INSTALLATION EXAMPLES

All the examples of installations can be mirrored. The valve position scale can be turned over and rotated to fit a number of installation layouts and should at the installation be fitted in the correct position as shown in the instruction for installation. The symbol markings of the valve ports (■●▲) minimize the risk of incorrect installation.

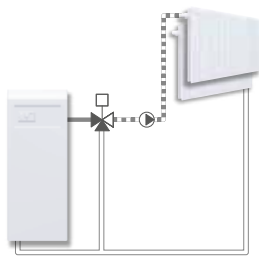

Mixing

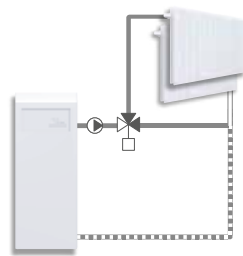

Diverting



VALVE VRG130 DESIGNED FOR

- Heating
- Comfort cooling
- Floor heating
- Solar heating
- Ventilation
- Zone

SUITABLE ACTUATORS AND CONTROLLERS

- Series ARA600
- Series 90*
- Series 90C
- Series CRA110, CRA120*, CRA140, CRA150
- Series CRB100
- Series CRC110, CRC120*, CRC140
- Series CRD100
- Series CRS130

*Adaptor kit necessary

TECHNICAL DATA

Pressure class: _____ PN 10
 Media temperature: _____ max. (continuously) +110°C
 _____ max. (temporarily) +130°C
 _____ min. -10°C
 Torque (at nominal pressure) DN15-32: _____ < 3 Nm
 DN40-50: _____ < 5 Nm
 Leakrate in % of flow*: _____ Mixing < 0.05%
 _____ Diverting < 0.02%
 Working pressure: _____ 1 MPa (10 bar)
 Max. differential pressure drop: _____ Mixing, 100 kPa (1 bar)
 _____ Diverting, 200 kPa (2 bar)
 Close off pressure: _____ 200 kPa (2 bar)
 Rangeability Kv/Kv^{min}, A-AB: _____ 100
 Connections: _____ Internal thread, EN 10226-1
 _____ External thread, ISO 228/1
 _____ Compression fitting, EN 1254-2

* Differential pressure 100kPa (1 bar)

Material

Valve body: _____ Dezincification resistant brass, DZR
 Slide: _____ Abrasion resistant brass
 Shaft and bushing: _____ PPS composite
 O-rings: _____ EPDM

PED 2014/68/EU, article 4.3

VALVE CHARACTERISTICS

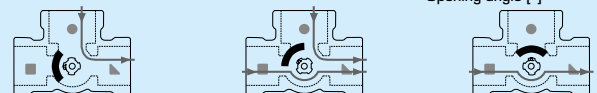
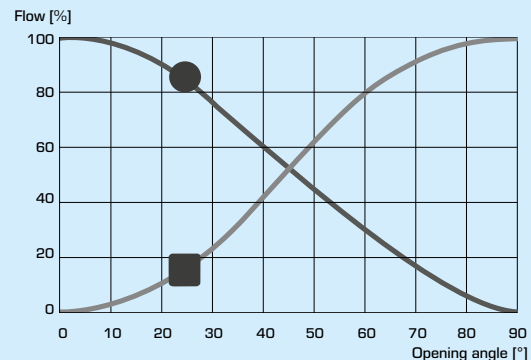

MIXING VALVE SERIES VRG130

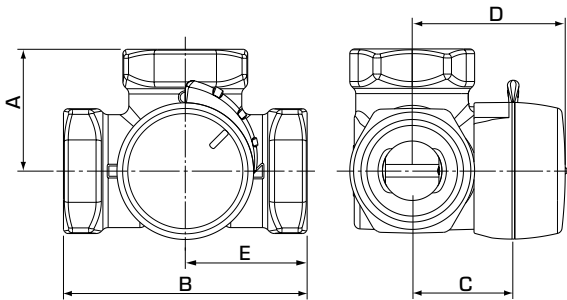

VRG131, VRG132, VRG133

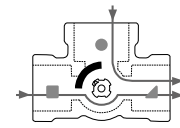

Mixing

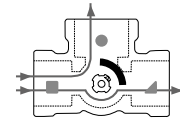

Diverting

The flat-sided spindle top points towards the sleeve position.

SERIES VRG131, INTERNAL THREAD

Art. No.	Reference	DN	Kvs *	Connection	A	B	C	D	E	Weight [kg]	Replaces
11600100	VRG131	15	0.4	Rp 1/2"	36	72	32	50	36	0.40	
11600200			0.63								
11600300			1								
11600400			1.6								
11600500			2.5								
11600600	4										
11600700	VRG131	20	2.5	Rp 3/4"	36	72	32	50	36	0.43	
11600800			4								
11600900			6.3								
11601000	VRG131	25	6.3	Rp 1"	41	82	34	52	41	0.70	
11601100			10								
11601200	VRG131	32	16	Rp 1 1/4"	47	94	37	55	47	0.95	
11603400	VRG131	40	25	Rp 1 1/2"	53	106	44	62	53	1.68	
11603600	VRG131	50	40	Rp 2"	60	120	46	64	60	2.30	

SERIES VRG132, EXTERNAL THREAD

Art. No.	Reference	DN	Kvs *	Connection	A	B	C	D	E	Weight [kg]	Replaces
11601500	VRG132	15	0.4	G 3/4"	36	72	32	50	36	0.40	
11601600			0.63								
11601700			1								
11601800			1.6								
11601900			2.5								
11602000	4										
11602100	VRG132	20	2.5	G 1"	36	72	32	50	36	0.43	
11602200			4								
11602300			6.3								
11602400	VRG132	25	6.3	G 1 1/4"	41	82	34	52	41	0.70	
11602500			10								
11602600	VRG132	32	16	G 1 1/2"	47	94	37	55	47	0.95	
11603500	VRG132	40	25	G 2"	53	106	44	62	53	1.69	
11603700	VRG132	50	40	G 2 1/4"	60	120	46	64	60	2.30	

SERIES VRG133, COMPRESSION FITTING

Art. No.	Reference	DN	Kvs *	Connection	A	B	C	D	E	Weight [kg]	Replaces
11602900	VRG133	20	4	CPF 22 mm	36	72	32	50	36	0.40	
11603000			6.3								
11603100	VRG133	25	10	CPF 28 mm	41	82	34	52	41	0.45	

* Kvs-value in m³/h at a pressure drop of 1 bar: Flow chart, see product catalogue. CPF = compression fitting

MIXING VALVE SERIES VRG130

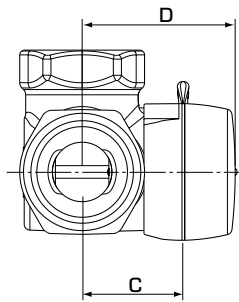

VRG138, VRG139

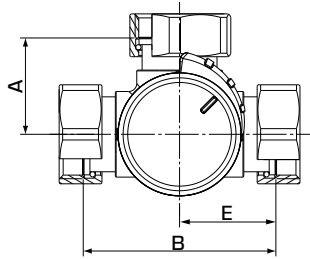

VRG138

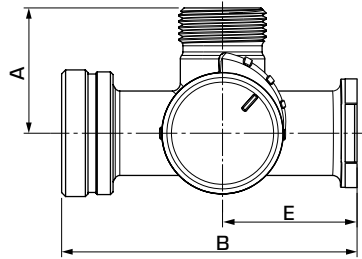

VRG139

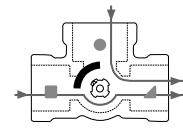

Mixing

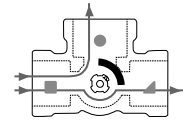

Diverting

The flat-sided spindle top points towards the sleeve position.

SERIES VRG138, ROTATING NUT AND EXTERNAL THREAD

Art. No.	Reference	DN	Kvs *	Connection	A	B	C	D	E	Weight [kg]	Replaces
11603800	VRG138	20	4	2x RN 1" + G 1"	36	72	32	50	36	0.56	
11603900			4	3x RN 1"						0.59	
11604000			6.3	2x RN 1" + G 1"						0.56	
11604100			6.3	3x RN 1"						0.59	

SERIES VRG139, PUMP FLANGE AND EXTERNAL THREAD

Art. No.	Reference	DN	Kvs *	Connection	A	B	C	D	E	Weight [kg]	Replaces
11604400	VRG139	20	2.5	PF 1½" + G 1½" + G 1"	47.5	112	32	50	51	0.82	1100 55 00
11604500			6.3							0.82	1100 56 00
11604600			8							0.82	1100 20 00

* Kvs-value in m³/h at a pressure drop of 1 bar. Flow chart, see product catalogue. RN = Rotating Nut PF = Pump flange

MIXING VALVE SERIES VRG130

DIMENSIONING

RADIATOR OR UNDERFLOOR HEATING SYSTEMS

Start with the heat demand in kW (e.g. 25 kW) and move vertically to the chosen Δt (e.g. 15°C).

Move horizontally to the shaded field (pressure drop of 3-15 kPa) and select the smaller Kvs-value (e.g. 4.0). A mixing valve with suitable Kvs-value will be found in respective product description.

OTHER APPLICATIONS

Make sure maximum ΔP is not exceeded (see lines A and B in the graph below).

